

DMC 200S - PLYWOOD

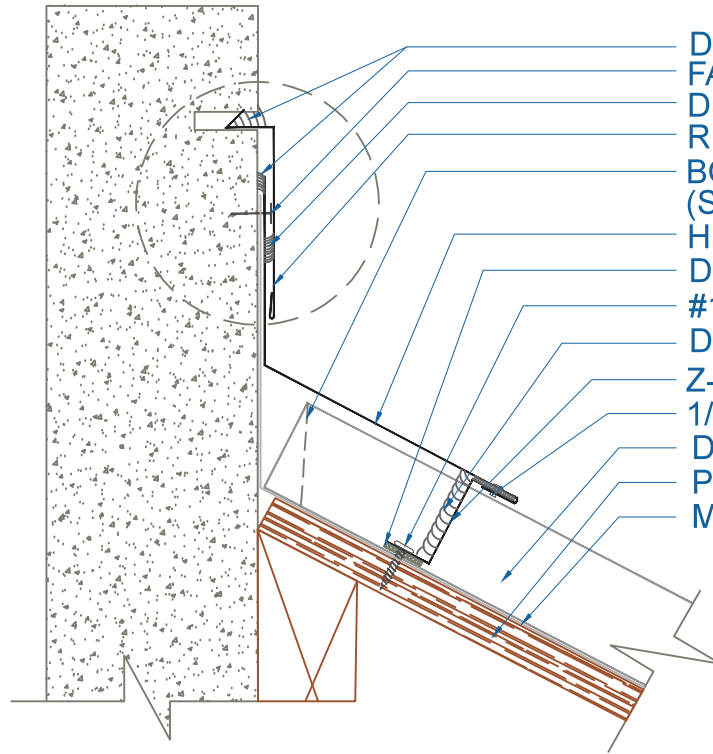

- DREXEL APPROVED TUBE SEALANT
- FASTENERS (BY OTHERS)
- DREXEL APPROVED TUBE SEALANT
- REGLET FLASHING
- BOX END OF PANEL
(SEE ZEE CLOSURE OPTIONS DETAIL)
- HEADWALL FLASHING
- D.B. TAPE SEALANT
- #10 - 13 x 1" PHW (5 PER PANEL)
- DREXEL APPROVED TUBE SEALANT
- Z-CLOSURE FLASHING
- 1/8" - #43 POP RIVET (18" o.c.)
- DMC 200S PANEL
- PLYWOOD SUBSTRATE (1/2" MIN.)
- METSHIELD UNDERLAYMENT

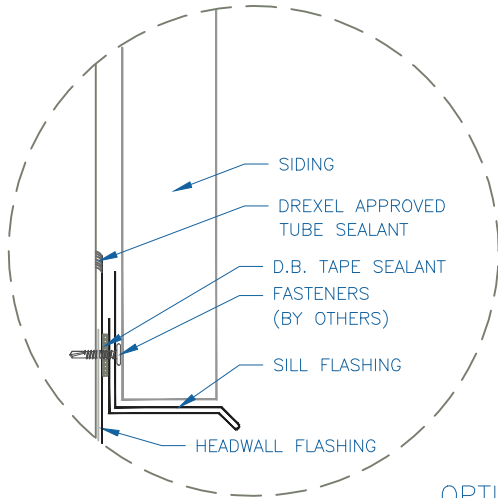

OPTION 1

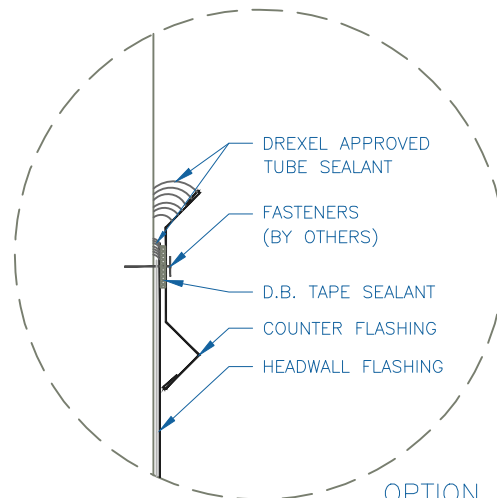

OPTION 2

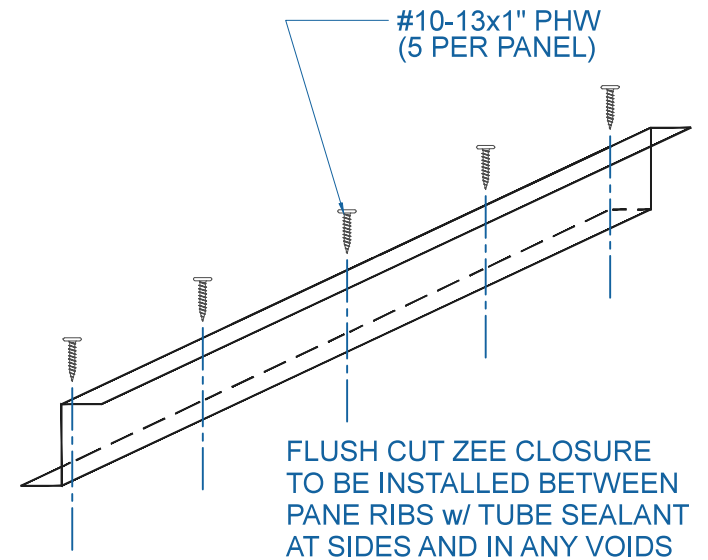

FLUSH CUT ZEE CLOSURE
TO BE INSTALLED BETWEEN
PANE RIBS w/ TUBE SEALANT
AT SIDES AND IN ANY VOIDS

EFFECTIVE DATE: 12-11-12
SUBJECT TO CHANGE WITHOUT NOTICE

HEADWALL

SCALE: 3" = 1'-0"