

DMC 200S - OPEN FRAMING

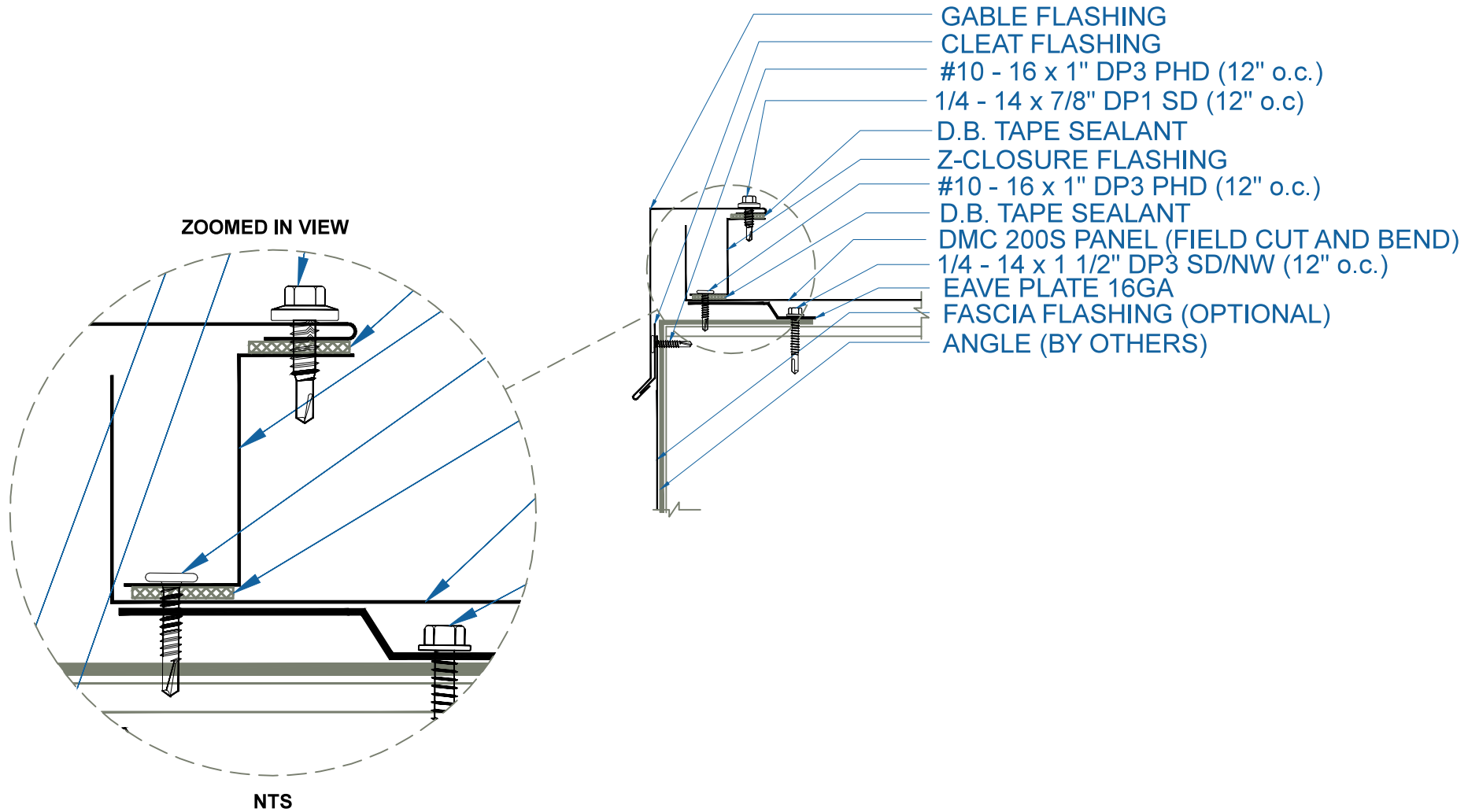

EFFECTIVE DATE: 01-16-14
SUBJECT TO CHANGE WITHOUT NOTICE

GABLE
SCALE: 3" = 1'-0"

DrexelMetals
Roofing Systems + Custom Fabrication

