

DMC 200S - PLYWOOD

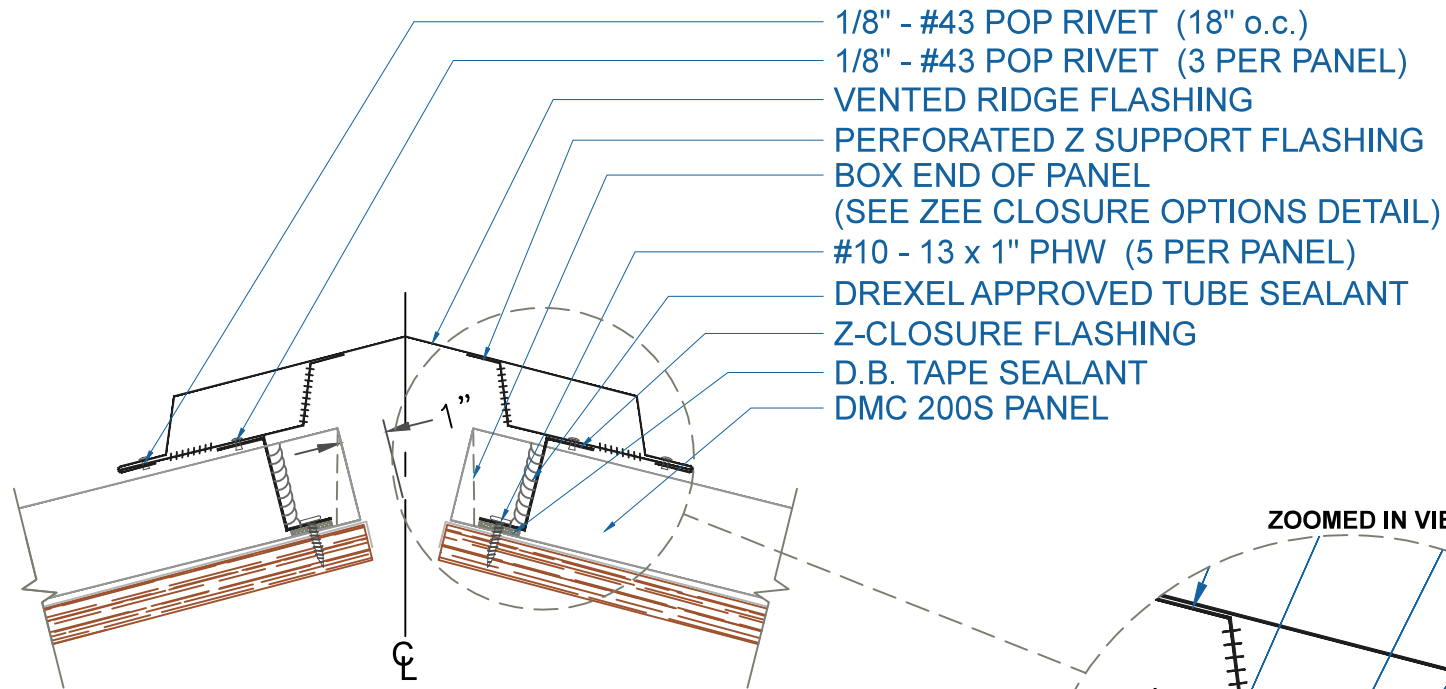

NOTE:
 1.) NET FREE AREA = 6.16 SQ IN/FT

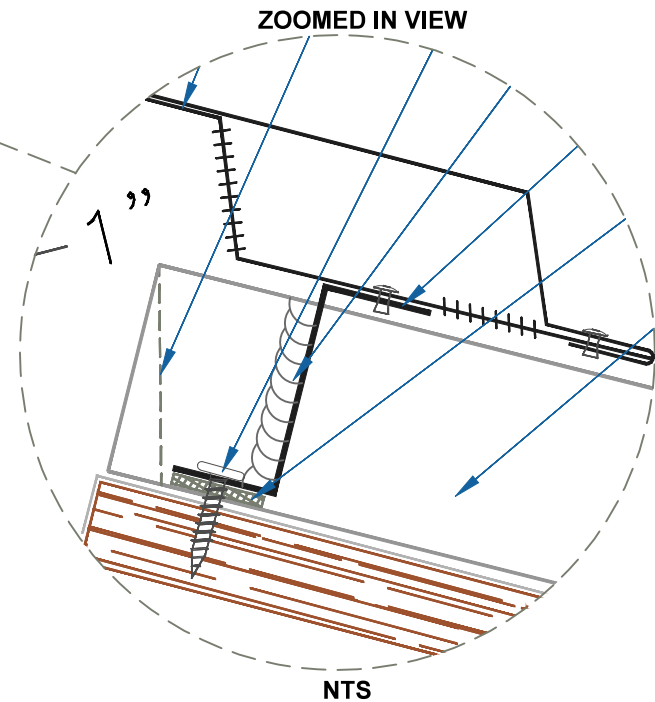
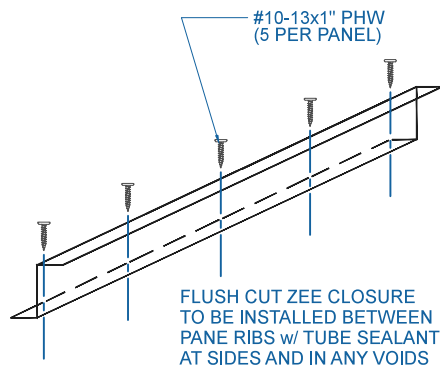

VENTED RIDGE / HIP

SCALE: 3" = 1'-0"

EFFECTIVE DATE: 12-11-12
 SUBJECT TO CHANGE WITHOUT NOTICE