

# DMC 175S - PLYWOOD

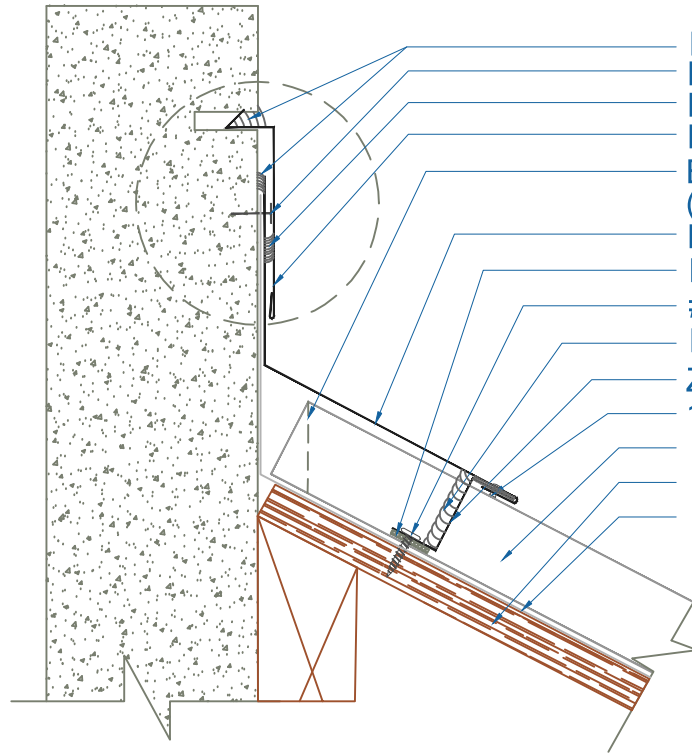

- DREXEL APPROVED TUBE SEALANT
- FASTENERS (BY OTHERS)
- DREXEL APPROVED TUBE SEALANT
- REGLET FLASHING
- BOX END OF PANEL  
(SEE ZEE CLOSURE OPTIONS DETAIL)
- HEADWALL FLASHING
- D.B. TAPE SEALANT
- #10 - 13 x 1" PHW (5 PER PANEL)
- DREXEL APPROVED TUBE SEALANT
- Z-CLOSURE FLASHING
- 1/8" - #43 POP RIVET (18" o.c.)
- DMC 175S PANEL
- PLYWOOD SUBSTRATE (1/2" MIN.)
- METSHIELD UNDERLAYMENT

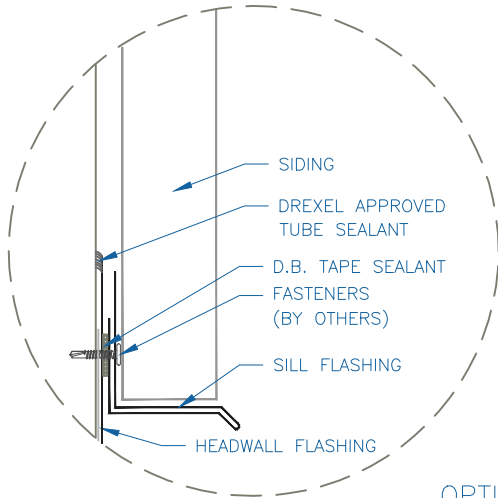

OPTION 1

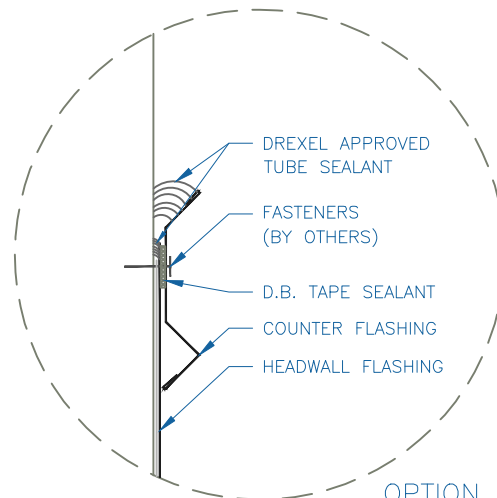

OPTION 2

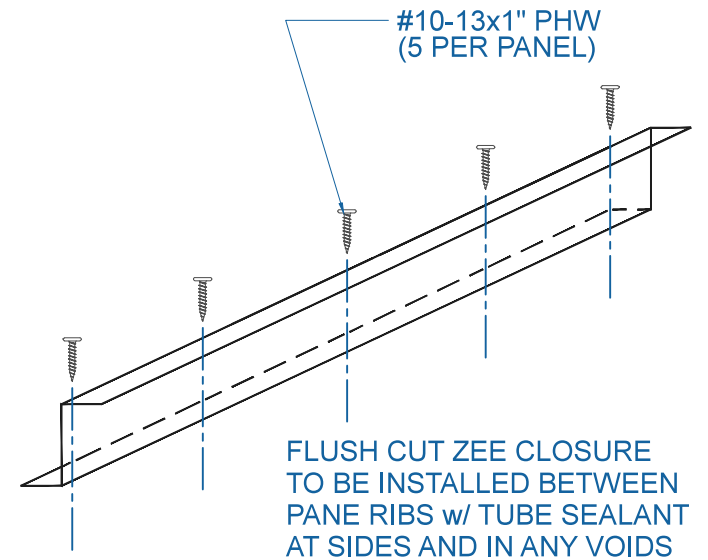

FLUSH CUT ZEE CLOSURE  
TO BE INSTALLED BETWEEN  
PANE RIBS w/ TUBE SEALANT  
AT SIDES AND IN ANY VOIDS

EFFECTIVE DATE: 12-11-12  
SUBJECT TO CHANGE WITHOUT NOTICE

## HEADWALL

SCALE: 3" = 1'-0"