

DREXEL METALS CLIPS AND ACCESSORIES

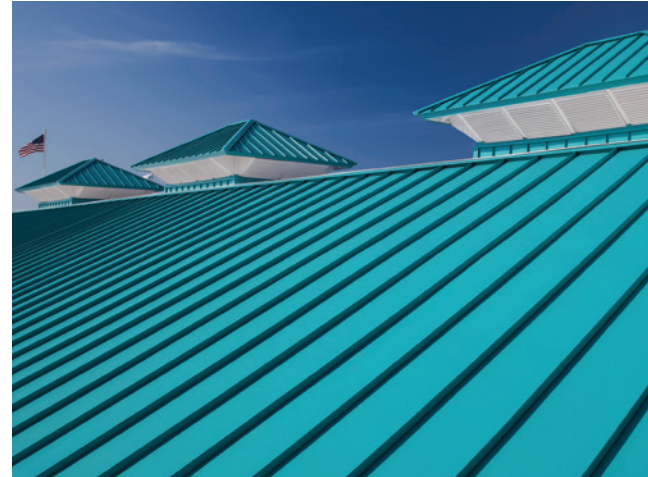
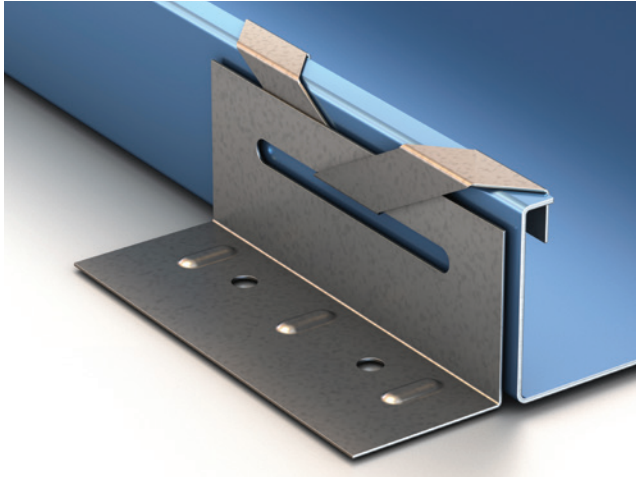

SIMPLIFYING METAL ROOFING SYSTEMS

Your machine makes one component of the total metal roof system. Drexel Metals has invested millions of dollars to ensure our metal roof system meets the required building codes. Together with our QA program, DM-ARM Authorized Fabricator and Certified Installer Program, you can install the total Drexel Metals system with the peace of mind that Drexel Metals will stand behind our products 100%. Enroll in our Gold Standard Paint Warranty Program, and you will have a competitive advantage to compete with anyone! Our Gold Standard Paint Warranty is the strongest warranty in the industry, covering labor and materials, and is also transferrable for the life of the warranty.

ARCHITECTURAL • COMMERCIAL • RESTORATION/CUSTOM



SNAP LOCK CLIPS

PANEL | DMC 175S

CLIP | DMC 175S UL

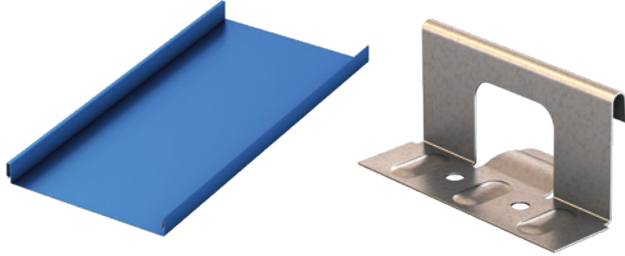

PART	PRODUCT	PCS/BOX	STOCK
2002	HD GALV.	250	IN STOCK
2007	STAINLESS	250	IN STOCK
2046	3X3 BEARING PLATES	300	IN STOCK

PART	PRODUCT	PCS/BOX	STOCK
2014	HD GALV.	500	IN STOCK
2037	STAINLESS	500	IN STOCK

PANEL | DMC 175S

CLIP | DMC 175S NON UL

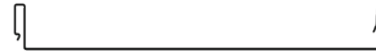
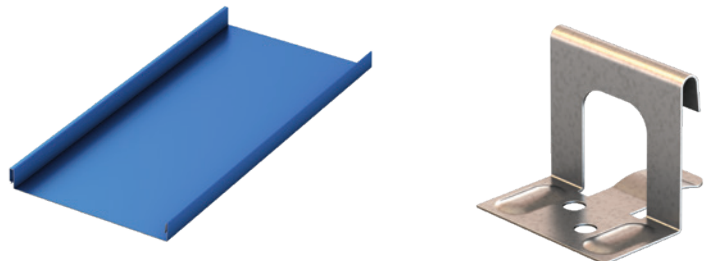

PANEL | DMC 450

CLIP | DMC 450

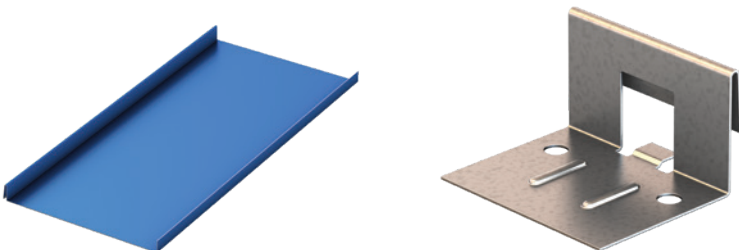

PART	PRODUCT	PCS/BOX	STOCK
2058	HD GALV.	800	IN STOCK
2059	STAINLESS	800	IN STOCK



SNAP LOCK CLIPS

PANEL | DMC 450SL

CLIP | DMC 450SL UL

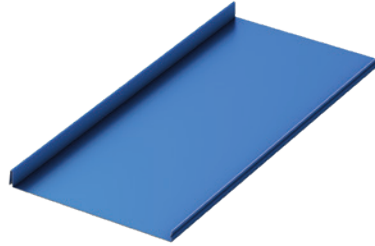

PART	PRODUCT	PCS/BOX	STOCK
2077	HD GALV	250	IN STOCK
2078	STS	250	IN STOCK

* NON-UL CLIP AVAILABLE

PANEL | DMC 550S

CLIP | DMC 550S UL

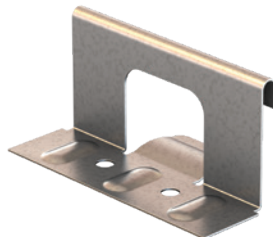
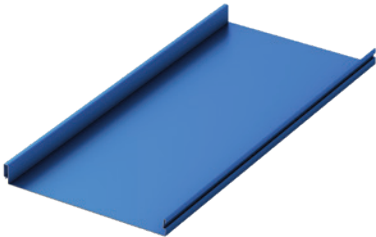

PART	PRODUCT	PCS/BOX	STOCK
2072	GALV	300	IN STOCK
2073	STS	300	IN STOCK



GET THE EDGE ES-1 ARM CERTIFICATION PROGRAM

Drexel Metals' ES-1 ARM Certification Program is designed for Drexel Metals authorized ARM Members who want the capability and flexibility of fabricating their own ES-1 compliant edge metal. Contact us for more details today!



STANDING SEAM CLIPS

PANEL | DMC 200S

CLIP | DMC 200S FLOATING

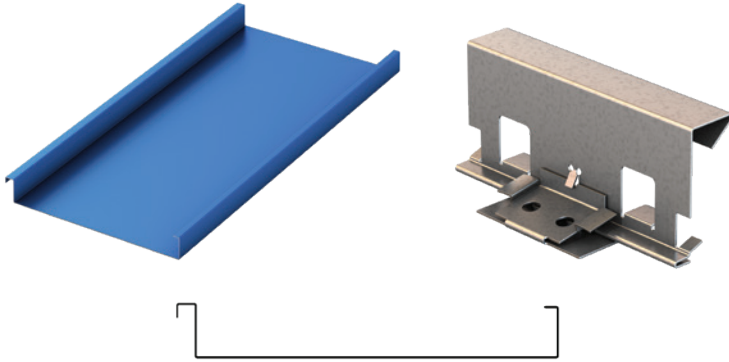

PART	HEIGHT	PRODUCT	PCS/BOX	STOCK
2062	2 3/8"	HD GALV.	120	IN STOCK
2063	3"	HD GALV.	110	2-3 WEEKS

PANEL | DMC 200S

CLIP | DMC 200S BUTTERFLY

PART	PRODUCT	PCS/BOX	STOCK
2003	HD GALV. TOP	150	IN STOCK
2005	HD GALV. BASE	150	IN STOCK
2024	STAINLESS TOP	150	IN STOCK
2025	STAINLESS BASE	150	IN STOCK
2026	HD GALV. 10'	1	CALL

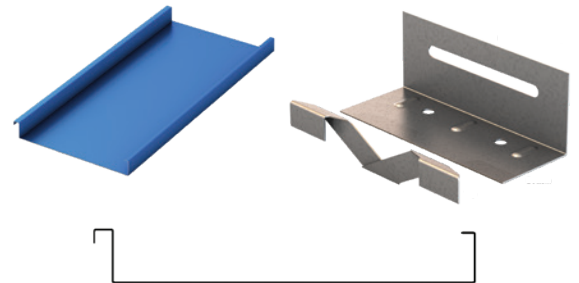

PANEL | DMC 200SS

CLIP | DMC 200S

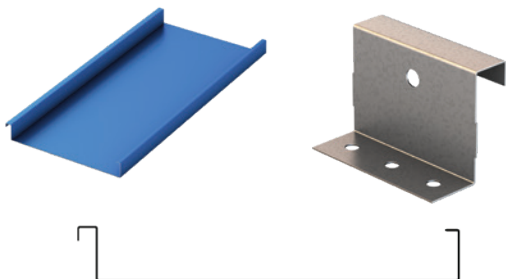

PART	PRODUCT	PCS/BOX	STOCK	GAUGE
2038	HD GALV.	300	IN STOCK	22
2039	STAINLESS	300	CALL	22
2013*	HD GALV.	300	IN STOCK	24
2046	3X3 BEARING PLATES	300	IN STOCK	

*Not tested or Miami-Dade approved.





STANDING SEAM CLIPS

PANEL | DMC 150SS

CLIP | DMC 150SS BUTTERFLY

PART	PRODUCT	PCS/BOX	STOCK
2008	HD GALV. TOP	200	IN STOCK
2006	HD GALV. BASE	200	IN STOCK
2035	STAINLESS TOP	200	IN STOCK
2036	STAINLESS BASE	200	IN STOCK
2030	HD GALV. 10'	1	CALL

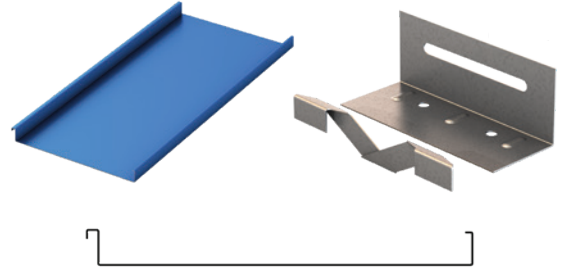

PANEL | DMC 150SS

CLIP | DMC 150SS

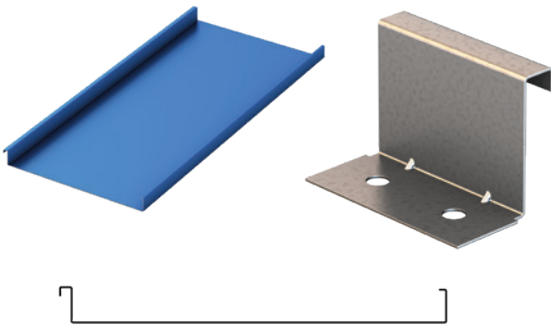

PART	PRODUCT	PCS/BOX	STOCK	GAUGE
2004	HD GALV.	1000	IN STOCK	24
2053	STAINLESS	1000	CALL	24
2012*	HD GALV.	1000	IN STOCK	26

*Not tested or Miami-Dade approved.



PANEL | DMC 150SS

CLIP | DMC 150SS

PART	PRODUCT	PCS/BOX	STOCK
2056	HD GALV.	250	IN STOCK
2057	STAINLESS	250	IN STOCK

ONLY STOCKED IN FL.

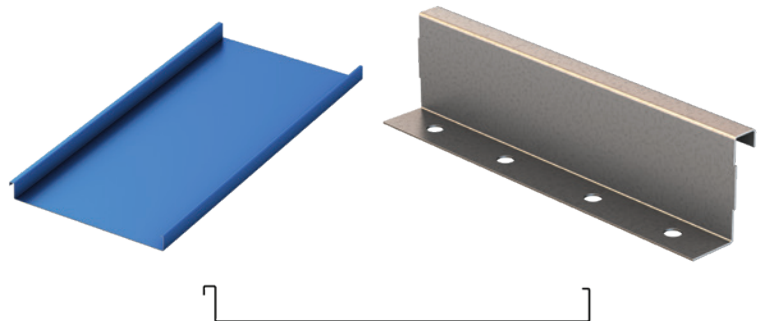



STANDING SEAM CLIPS

PANEL | DMC 100SS

CLIP | DMC 100SS

PART	PRODUCT	PCS/BOX	STOCK	GAUGE
2019	HD GALV.	1000	IN STOCK	24
2034	STAINLESS	1000	IN STOCK	24
2001	HD GALV.	1000	IN STOCK	26

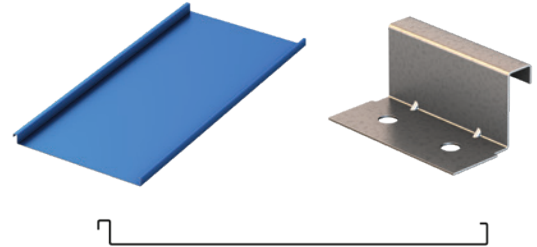

BATTEN CLIPS

PANEL | DMC CAP SEAM

CLIP | CAP SEAM 1 1/2"

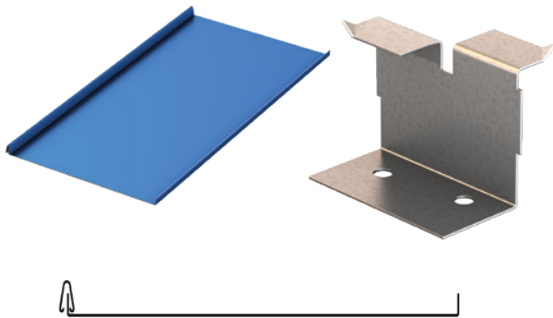

PART	PRODUCT	PCS/BOX	STOCK
2047	HD GALV.	500	IN STOCK
2048	STAINLESS	500	7-10 DAYS

PANEL | DMC CAP SEAM

CLIP | DMC CAP SEAM 1"

PART	PRODUCT	PCS/BOX	STOCK
2018	HD GALV.	1000	IN STOCK
7-10 DAYS	STAINLESS	1000	CALL

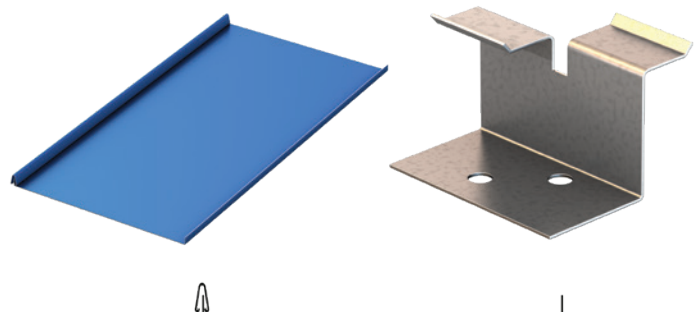



BATTEN CLIPS

PANEL | SNAP-ON BATTEN

CLIP | SNAP-ON BATTEN

PART	PRODUCT	PCS/BOX	STOCK
2049	HD GALV.	1000	CALL
2050	STAINLESS	1000	CALL

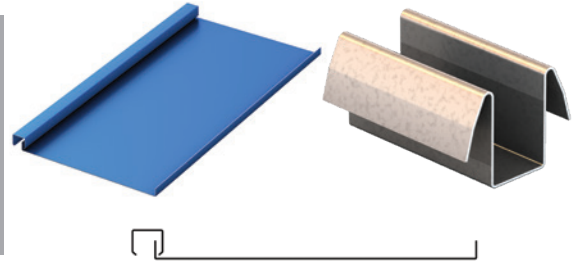

BERMUDA CLIPS & BEARING PLATES

PANEL | BERMUDA HORIZON

CLIP | BERMUDA HORIZON

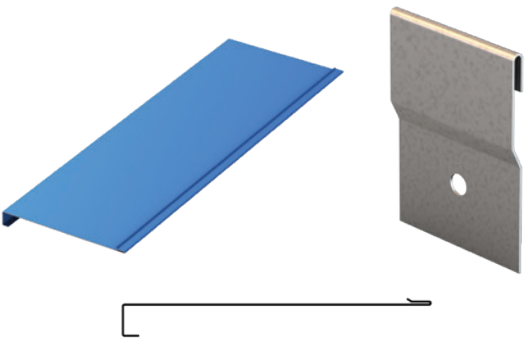

PART	PRODUCT	PCS/BOX	STOCK
2068	HD GALV.	1000	IN STOCK
2069	STAINLESS	1000	7-10 DAYS
2046	3X3 BEARING PLATES	300	IN STOCK



GUTTER HANGERS

GD-1 HANGERS FOR 7" BOX GUTTER

PART	PRODUCT	PCS/BOX	STOCK
12005	ALUMINUM	12	IN STOCK
12006	7" GALVANIZED	200	IN STOCK
12000	6" GALVANIZED	200	IN STOCK

CALL FOR STANDARD NON-GD-1 GUTTER HANGERS.

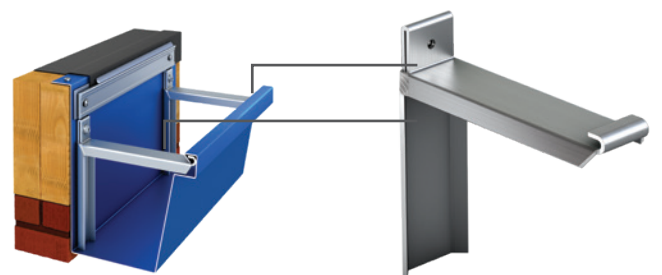



FASTENERS

PRODUCT	PRODUCT NAME	DMC PART NO.	AVAILABLE LENGTHS	CARTON QUANTITY
---------	--------------	--------------	-------------------	-----------------



For use with any Drexel Metals metal roofing system installed over plywood or wood trusses. Stainless is required when installing over any pressure treated or marine grade plywood.

#10 - 13
Pancake screw
A point

Carbon:
1" - #3002
1.5" - #3003
Stainless:
1" - #3004
1.5" - #3011

1"
1.5"

5K Screws - 1"
3K Screws - 1.5"



For use with any Drexel Metals metal roofing product installed over steel decking or metal trusses. Perfect for metal to metal applications!

#10 - 16
Pancake screw
Self Driller

#3017

1"

5K Screws



For use with any Drexel Metals metal roofing system installed over plywood decks or wood trusses.

#10 - 9
Low Profile Clip
Screw

#3001

1.125"

5K Screws - 1.125"



For use with any Drexel Metals metal roofing system installed over rigid insulation.

#14 - 13
Pancake Screw

Carbon:
2" - #3024
3" - #3026
4" - # 3018
5" - # 3016
6" - # 3007
7" - # 3019
Stainless: CALL

1.5", 2", 3" 4" 4.5" 5", 6", 7",
8" & 9"
(3-5 day lead-time)

2,5K Screws - 1.5"
1K Screws - 2" & 3"
500 Screws - 4" to 7"
250 Screws - 8" & 9"



For use with any Drexel Metals metal roofing system installed with an exposed fastener into wood.

#10 - 14
Panel Tite Wood Screws

3000 - Color
3" - # 3027
4" - # 3028
5" - # 3029
6" - # 3030
7" - # 3031
9" - # 3034

1", 1.5", 2",
2.5" & 3"
Drexel Metals Stocks 1.5"
Painted In Our Standard Colors

3K Screws - 1"
2,5K Screws - 1.5"
2K Screws - 2"
1,5K Screws - 2.5"
1K Screws - 3"
500 Screws - 4" to 9"



For use with any Drexel Metals metal roofing system where metal to metal needs to be sealed. Perfect for floating panels.

#12 - 14
Zinc
Cap Head

3300 - Color

1.5"
(5-7 day lead-time)

1,5K Screws - 1.5"



DREXEL METALS UNDERLAYMENT

METSHIELD HIGH-TEMP UNDERLAYMENT

DM PART NO.	PRODUCT	SQ FT PER ROLL	ROLLS PER PALLET	STOCK
13000	METSHIELD PEEL & STICK	198 SF	25	IN STOCK
13003	WIP250	200 SF	25	IN STOCK

MetShield
Synthetic Underlayment

METSHIELD SYNTHETIC UNDERLAYMENT

DM PART NO.	PRODUCT	SQ FT PER ROLL	ROLLS PER PALLET	STOCK
13001	METSHIELD SYNTHETIC	1000 SF 931 SF AREA	36	IN STOCK

*USE 51 FASTENERS PER SF

MetShield
Synthetic Underlayment



PAINTED & MILL-FINISHED RIVETS (STAINLESS)

DM PART NO.	PRODUCT	QTY PER BOX	STOCK
4000 COLOR	#43 PAINTED RIVET	250	IN STOCK
4000 MF	#43 MILL-FINISHED RIVET	250	IN STOCK



THE ORIGINAL KYNAR® AIR-DRY PAINT PEN



DM PART NO.	PRODUCT	QTY PER BOX	STOCK
1000 COLOR	PAINT PEN	1	IN STOCK



S-5-V CLAMPS

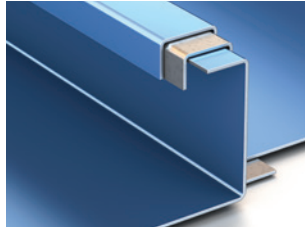

DMC 200 90° SEAM



DMC 550S

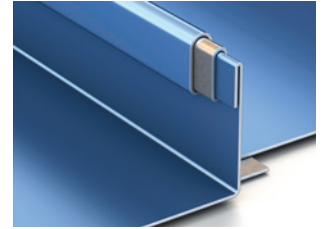

DMC 200S 180° SEAM

S-5-V CLAMPS WORK WITH THESE DREXEL METALS PANEL SEAM PROFILES.

DM PART NO.	PRODUCT	QTY PER BOX	STOCK
7015	S-5-V	30 UNITS PER BOX	IN STOCK

5-S-E CLAMPS

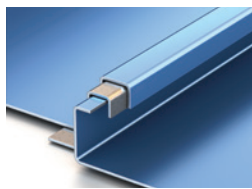

DMC 100SS
90° SEAM

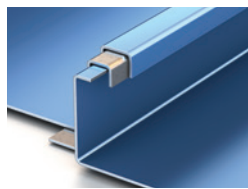

DMC 150SS
90° SEAM

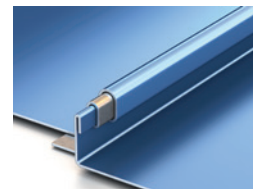

DMC 100SS
180° SEAM



DMC 150SS
180° SEAM

S-5-E CLAMPS WORK WITH THESE DREXEL METALS PANEL SEAM PROFILES.

DM PART NO.	PRODUCT	QTY PER BOX	STOCK
7004	S-5-E	60 UNITS PER BOX	IN STOCK

5-S-S CLAMPS

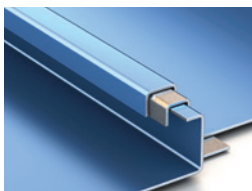

DMC 100SS 90° S
DMC 150SS 90° S



DMC 150SL



DMC 175S



DMC CAP SEAM

S-5-S CLAMPS WORK WITH THESE DREXEL METALS PANEL SEAM PROFILES.

DM PART NO.	PRODUCT	QTY PER BOX	STOCK
7006	S-5-S	30 UNITS PER BOX	IN STOCK



COLORGARD® SNOW RETENTION SYSTEM

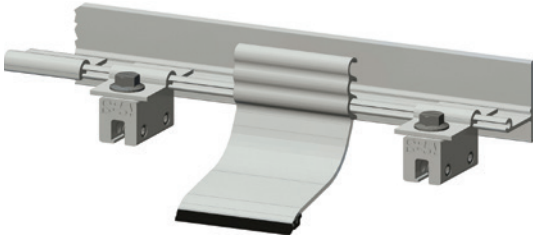

DM PART NO.	PRODUCT	QTY PER BOX	STOCK
7003	COLORGARD® UNPUNCHED	12	IN STOCK
7000	VERSA CLIP	100	IN STOCK
7002	SNOCLIP II	55	IN STOCK
7005	SNOCLIP III	35	IN STOCK

DREXEL METALS BUTYL TAPE

DM PART NO.	PRODUCT	DIMENSIONS	ROLLS PER BOX	STOCK
8000	DOUBLE BEAD BUTYL TAPE	3/16" X 7/8" X 40'	10	IN STOCK
8003	SINGLE BEAD BUTYL TAPE	1" X 3/32" X 50'	10	IN STOCK



DREXEL METALS SEALANT

DM PART NO.	PRODUCT	QTY PER BOX	STOCK
*5000	APS POLYMER	24	IN STOCK
5000 TRS	CLEAR	24	IN STOCK
5000 GRY	GRAY	24	IN STOCK
5004	SEAM ADHESIVE 915	24 10.1 OZ TUBES 12 20 OZ SAUSAGE	CALL
5003	SEAM ADHESIVE 70-05A	12 10 OZ 12 20 OZ SAUSAGE	CALL

* AVAILABLE IN LIMITED COLORS.





HEMMING TOOLS

PART 9116



PART 9115



PART 9114



PART 9087



DM PART NO.	PRODUCT	QTY PER BOX	STOCK
9018	11 1/4" HEMMING TOOL	1	IN STOCK
9028	15 1/4" HEMMING TOOL	1	IN STOCK
9004	15 1/4 HD COMBO	1	IN STOCK
9041	17 1/4" HEMMING TOOL	1	IN STOCK
9050	20" HEMMING TOOL	1	IN STOCK
9053	24" DBL HDL HEMMING TOOL	1	IN STOCK
9110	GO/NO-GO BLOCK KIT	1	IN STOCK
9112	CLIP SPACING GAUGE KIT	1	IN STOCK
9001	LEFT SNIPS (RED)	6/CASE	INSTOCK
9003	RIGHT SNIPS (GREEN)	6/CASE	IN STOCK
9012	OFFSET SEAMER TONGS	1	INSTOCK
9114	18" VALLEY FOLDER	1	IN STOCK
9115	3"-6" BLADE SEAMER	1	IN STOCK
9116	6" OFFSET STEAMER	1	IN STOCK
9087	3" STRAIGHT SEAM TONGS	1	IN STOCK





DREXEL METALS PIPE BOOTS



Drexel Metals has access to larger pipe boots as well high temp boots, color boots, retro-fit and square base with a 3 to 5 day lead-time. Please call your local sales representative or our technical office.

DM PART NO.	PRODUCT	QTY PER BOX	STOCK
6000	#2	1 3/4" - 3 1/4" PIPE	IN STOCK
6001	#3	1/4" - 4" PIPE	IN STOCK
6002	#4	3" - 6" PIPE	IN STOCK

Other sizes available.



HAND SEAMERS



DM PART NO.	PRODUCT	DM PANEL	STOCK
9005	90 HAND SEAMER	100SS/150SS	IN STOCK
9010	90 HAND SEAMER	200S	IN STOCK
9000	180 HAND SEAMER	100SS/150SS	IN STOCK
9015	180 HAND SEAMER	200S	IN STOCK





ON-DEMAND DELIVERY AND EXCEPTIONAL RESULTS



You can depend on Drexel Metals' quality materials and excellent service for your entire sheet and slit coil needs. We stock coil for your site-formed panels and flat material for all trim and fabrication applications. With our cut-to-length and recoil system, each order is fulfilled quickly and accurately.





DREXEL METALS PROMISE



Since 1985, Drexel Metals has provided a full range of superior-quality engineered metal roofing systems, equipment and custom fabrication services. Drexel Metals operates several sales, fabrication and distribution locations throughout the US. In addition to our own manufacturing abilities we extend our fabrication capacities to our local DM-ARM members, who are authorized fabricators, certified installers and distributors that further market Drexel Metals proven-brand products, all site-certified by Drexel Metals' industry-leading warranty programs. It's what we like to call Metal Roofing "On Demand"!

Driven by the tenets of customer service and integrity, Drexel Metals on-demand approach, premium quality fabrications and cost efficiency have landed our company, in terms of industry prestige, in the same place where our state-of-the-art roofs sit on a building – at the top. Using local empowerment, made-in-America sensibilities, and crafting a safe, attractive and endlessly reliable product, Drexel Metals looks to remain in our deservedly lofty perch. Thanks for your business!

Please call us if your product is not listed. We will use our experience to ensure we supply with the right product to make your projects more profitable and more efficient.



SALES AND DISTRIBUTION LOCATIONS



CORPORATE OFFICE AND MIDWEST SALES REGION

1234 Gardiner Lane
Louisville, KY 40213
888-321-9630 toll free
502-690-6174 fax

NORTHEAST/MIDATLANTIC SALES REGION

2101 Green Lane, Suite C
Levittown, PA 19057
888-321-9630 toll free
877-321-9638 fax

MIDATLANTIC SALES REGION

6930 San Tomas Road, Suite A
Elkridge, MD 21075
800-863-8322 toll free
410-799-9913 fax

SOUTHEASTERN SALES REGION

8641 Elm Fair Blvd
Tampa, FL 33610
888-321-9630 toll free
727-572-7910 fax

WESTERN SALES REGION

5981 Broadway
Denver, CO 80216
888-321-9630 toll free
303-340-0982 fax



1234 Gardiner Lane | Louisville, KY 40213
drexelmetals.com | 888-321-9630 | Fax: 877-321-9638