

DMC 200S - ISO w/ METAL DECK

ZOOMED IN VIEW

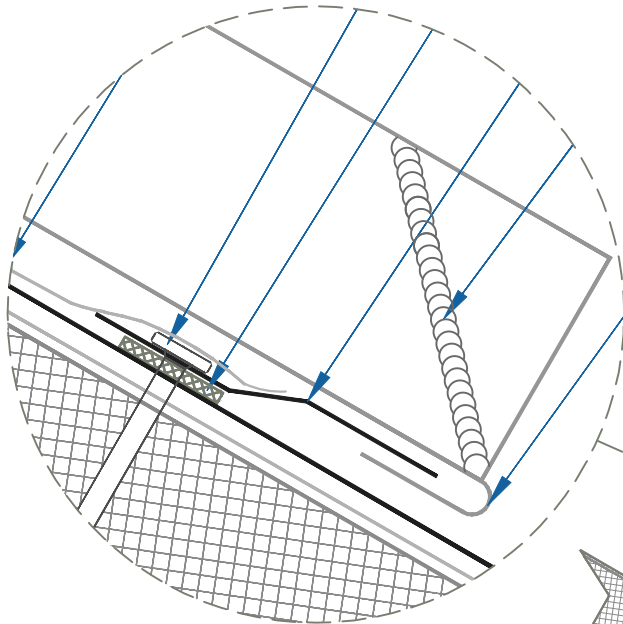

NTS

- DMC 200S PANEL
- METSHIELD UNDERLAYMENT
- #14 - 13 x ?" PHDD (12" o.c.)
- D.B. TAPE SEALANT
- OFFSET CLEAT FLASHING
- DREXEL APPROVED TUBE SEALANT (FIELD APPLIED BETWEEN PANEL RIBS)
- FIELD CUT & HEM PANEL 180°
- METSHIELD UNDERLAYMENT
- VALLEY W / DIVERTER FLASHING
- ISO INSULATION
- METAL DECK

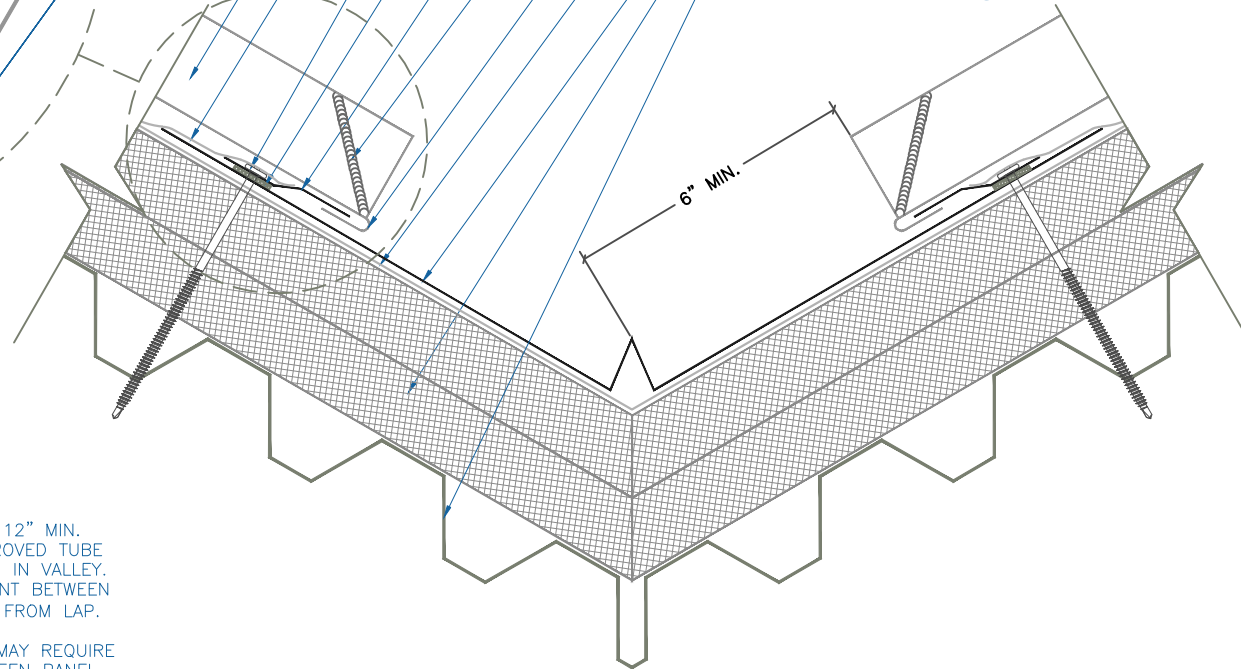

NOTE:

- 1.) LAPS IN VALLEY ARE 12" MIN. DREXEL METALS APPROVED TUBE SEALANT IN ALL LAPS IN VALLEY. TWO ROWS OF SEALANT BETWEEN VALLEY LAPS, 4" UP FROM LAP.
- 2.) LARGE ROOF AREAS MAY REQUIRE A LARGER GAP BETWEEN PANEL AND DIVERTER TO ALLOW FOR STORM WATER RUN OFF.

VALLEY W / DIVERTER

SCALE: 3" = 1'-0"

EFFECTIVE DATE: 04-12-2013
SUBJECT TO CHANGE WITHOUT NOTICE